

Squared Integrated Bench - Straight Module
300mm (H) Stapel Planter Edging
Velox Rapid Edge™ System

Logic Manufactured Bespoke™
technical@logic-bespoke.com
www.logic-bespoke.com
01642 373400

VELOX Rapid Edge™ UK00003507705
Patent no: GB2600394 & GB2614820
Registered Design - Europe: 008214910 & UK: 90082149100001

Revision 2.0

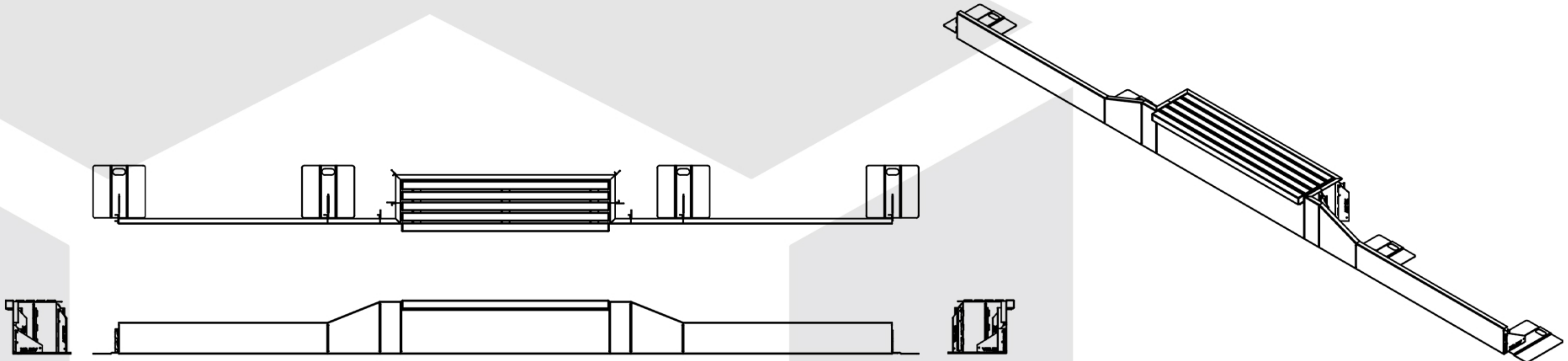

Contact the Technical Team for direct project input.
T: 01642 373400
E: technical@logic-bespoke.com

Squared Integrated Bench - Straight Module
400mm (H) Stapel Planter Edging
Velox Rapid Edge™ System

Logic Manufactured Bespoke™
technical@logic-bespoke.com
www.logic-bespoke.com
01642 373400

VELOX Rapid Edge™ UK00003507705
Patent no: GB2600394 & GB2614820
Registered Design - Europe: 008214910 & UK: 90082149100001

Revision 2.0

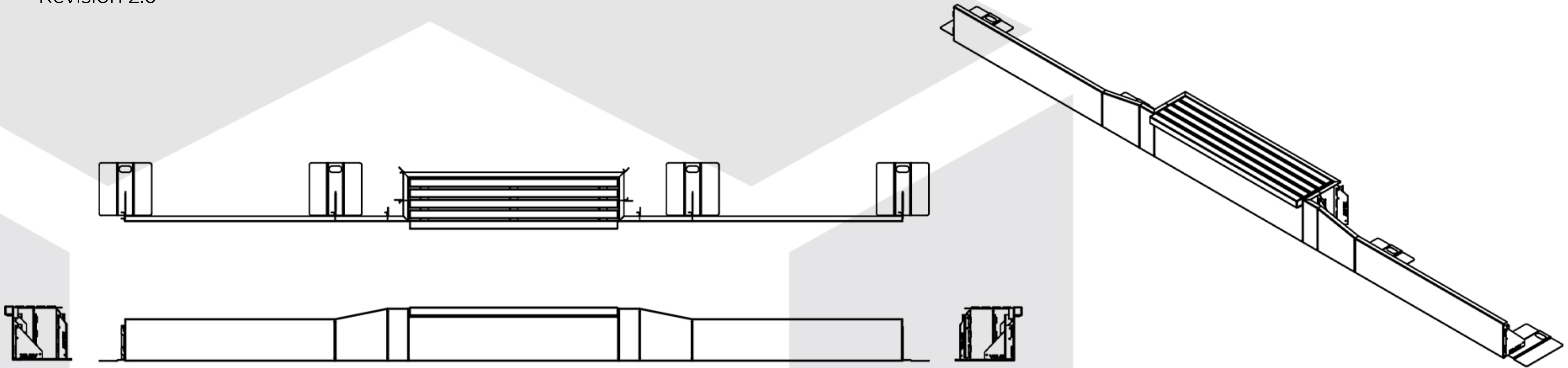

Contact the Technical Team for direct project input.
T: 01642 373400
E: technical@logic-bespoke.com

Squared Integrated Bench - Straight Module
500mm (H) Stapel Planter Edging
Velox Rapid Edge™ System

Logic Manufactured Bespoke™
technical@logic-bespoke.com
www.logic-bespoke.com
01642 373400

VELOX Rapid Edge™ UK00003507705
Patent no: GB2600394 & GB2614820
Registered Design - Europe: 008214910 & UK: 90082149100001

Revision 2.0

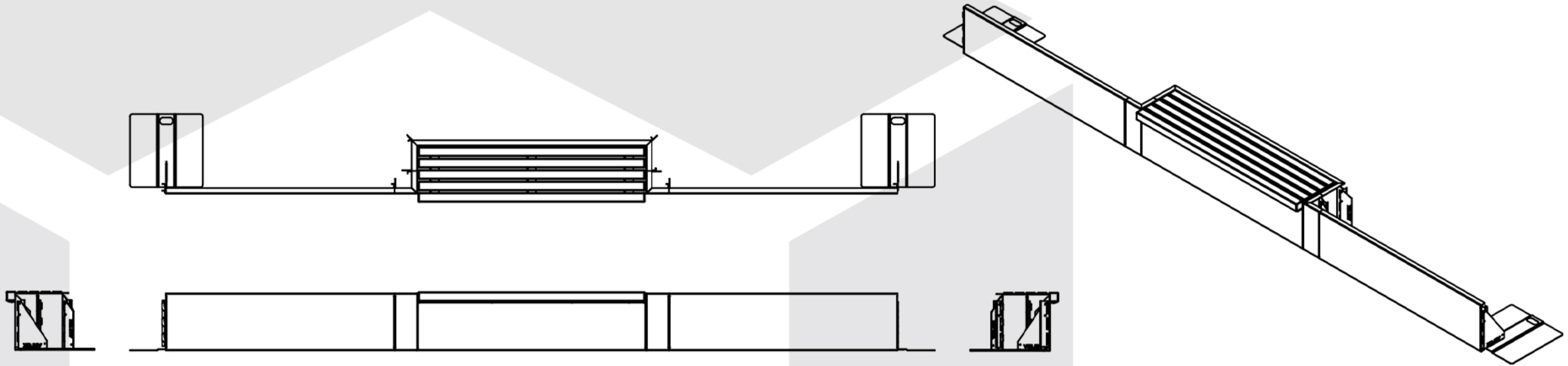

Contact the Technical Team for direct project input.
T: 01642 373400
E: technical@logic-bespoke.com

Squared Integrated Bench - Straight Module
600mm (H) Stapel Planter Edging
Velox Rapid Edge™ System

Logic Manufactured Bespoke™
technical@logic-bespoke.com
www.logic-bespoke.com
01642 373400

VELOX Rapid Edge™ UK00003507705
Patent no: GB2600394 & GB2614820
Registered Design - Europe: 008214910 & UK: 90082149100001

Revision 2.0

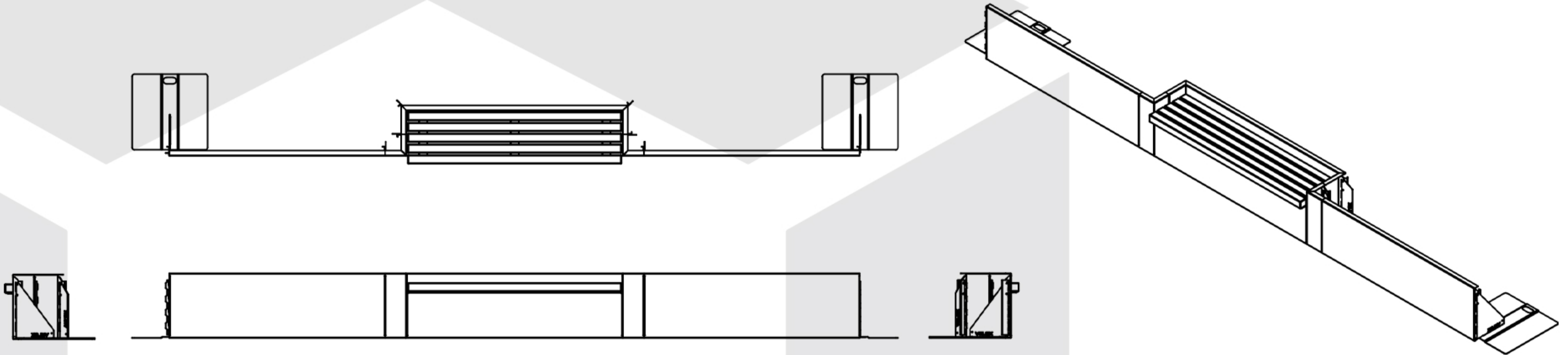

Contact the Technical Team for direct project input.
T: 01642 373400
E: technical@logic-bespoke.com

Squared Integrated Bench - Straight Module
700mm (H) Stapel Planter Edging
Velox Rapid Edge™ System

Logic Manufactured Bespoke™
technical@logic-bespoke.com
www.logic-bespoke.com
01642 373400

VELOX Rapid Edge™ UK00003507705
Patent no: GB2600394 & GB2614820
Registered Design - Europe: 008214910 & UK: 90082149100001

Revision 2.0

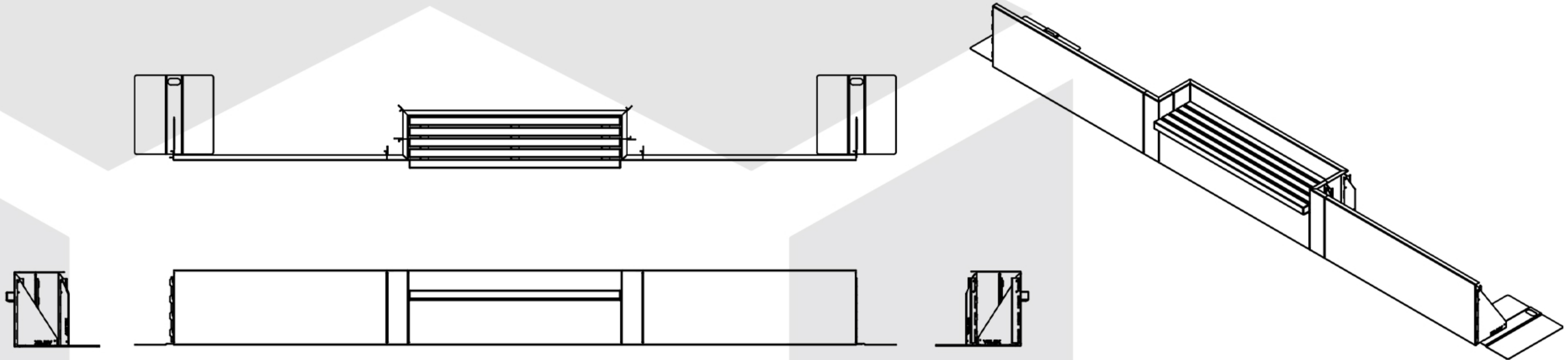

Contact the Technical Team for direct project input.
T: 01642 373400
E: technical@logic-bespoke.com

Squared Integrated Bench - Straight Module
800mm (H) Stapel Planter Edging
Velox Rapid Edge™ System

Logic Manufactured Bespoke™
technical@logic-bespoke.com
www.logic-bespoke.com
01642 373400

VELOX Rapid Edge™ UK00003507705
Patent no: GB2600394 & GB2614820
Registered Design - Europe: 008214910 & UK: 90082149100001

Revision 2.0

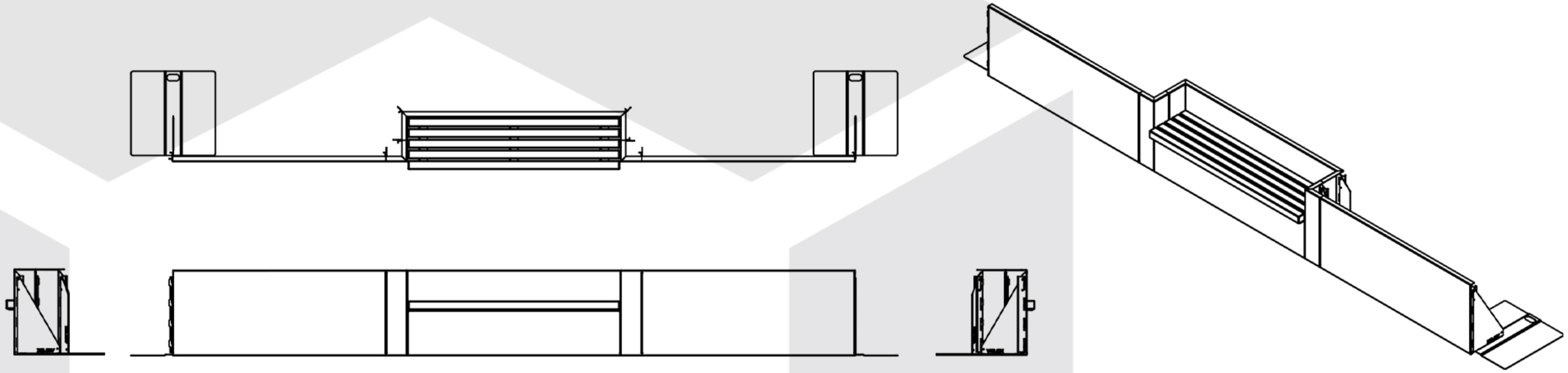

Contact the Technical Team for direct project input.
T: 01642 373400
E: technical@logic-bespoke.com

Squared Integrated Bench - Straight Module
900mm (H) Stapel Planter Edging
Velox Rapid Edge™ System

Logic Manufactured Bespoke™
technical@logic-bespoke.com
www.logic-bespoke.com
01642 373400

VELOX Rapid Edge™ UK00003507705
Patent no: GB2600394 & GB2614820
Registered Design - Europe: 008214910 & UK: 90082149100001

Revision 2.0

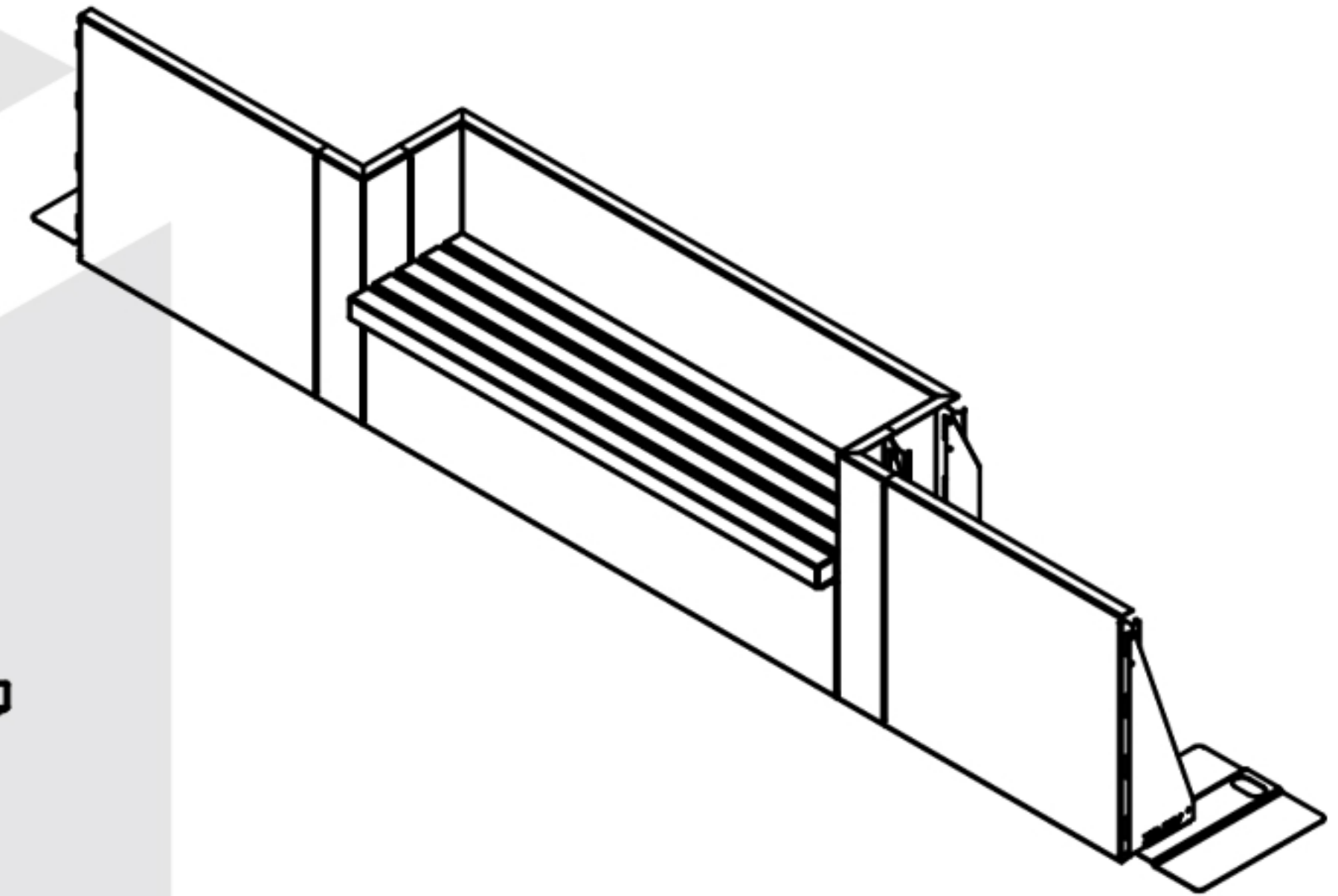

Contact the Technical Team for direct project input.
T: 01642 373400
E: technical@logic-bespoke.com

Squared Integrated Bench - Straight Module
1000mm (H) Stapel Planter Edging
Velox Rapid Edge™ System

Logic Manufactured Bespoke™
technical@logic-bespoke.com
www.logic-bespoke.com
01642 373400

VELOX Rapid Edge™ UK00003507705
Patent no: GB2600394 & GB2614820
Registered Design - Europe: 008214910 & UK: 90082149100001

Revision 2.0

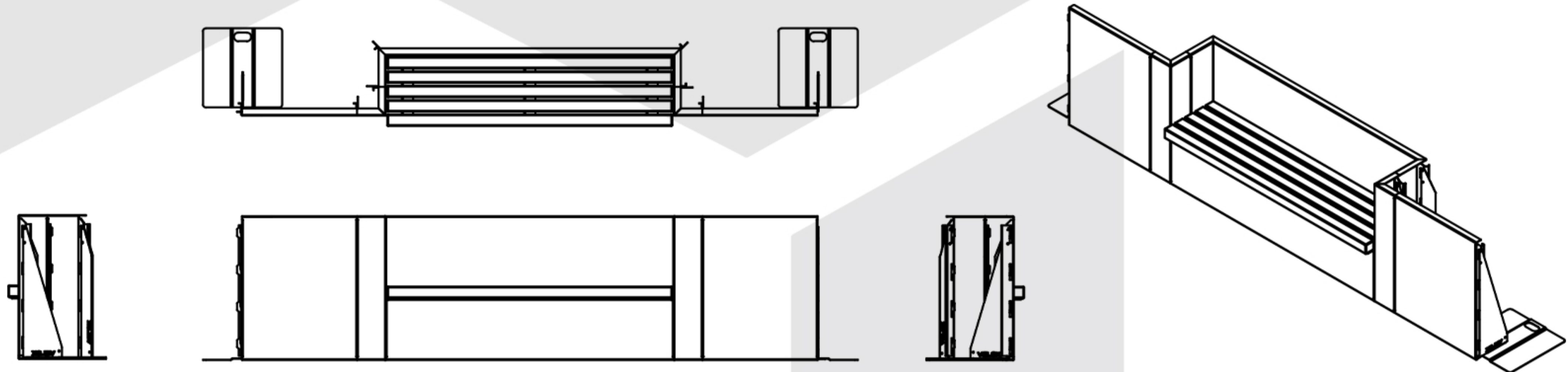

Contact the Technical Team for direct project input.
T: 01642 373400
E: technical@logic-bespoke.com

Squared Integrated Bench - Straight Module
1100mm (H) Stapel Planter Edging
Velox Rapid Edge™ System

Logic Manufactured Bespoke™
technical@logic-bespoke.com
www.logic-bespoke.com
01642 373400

VELOX Rapid Edge™ UK00003507705
Patent no: GB2600394 & GB2614820
Registered Design - Europe: 008214910 & UK: 90082149100001

Revision 2.0

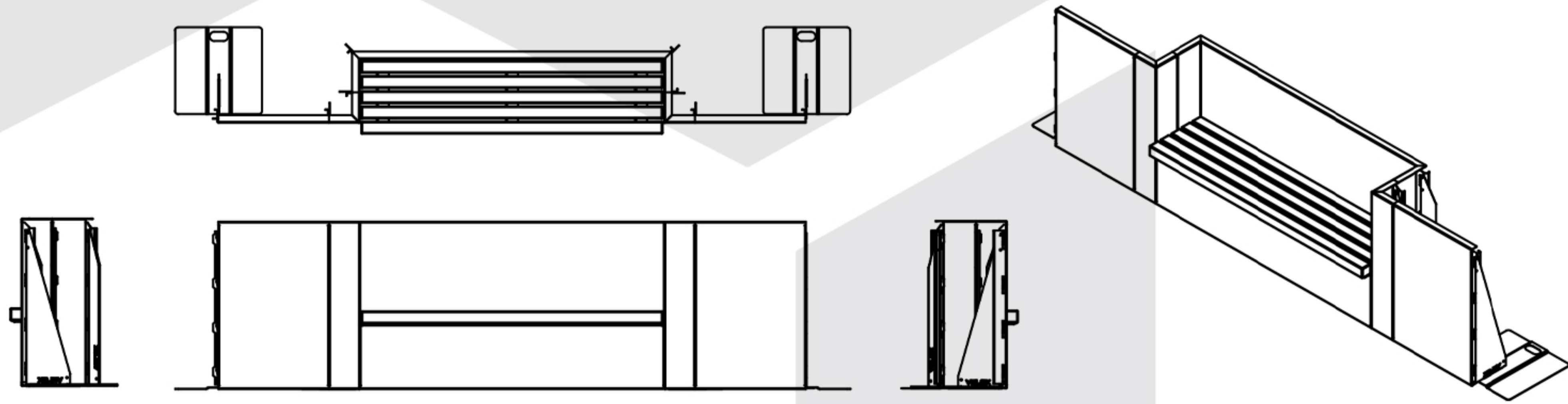

Contact the Technical Team for direct project input.
T: 01642 373400
E: technical@logic-bespoke.com