

SELF-WEIGHTED
VELOX RAPID EDGE
SYSTEM

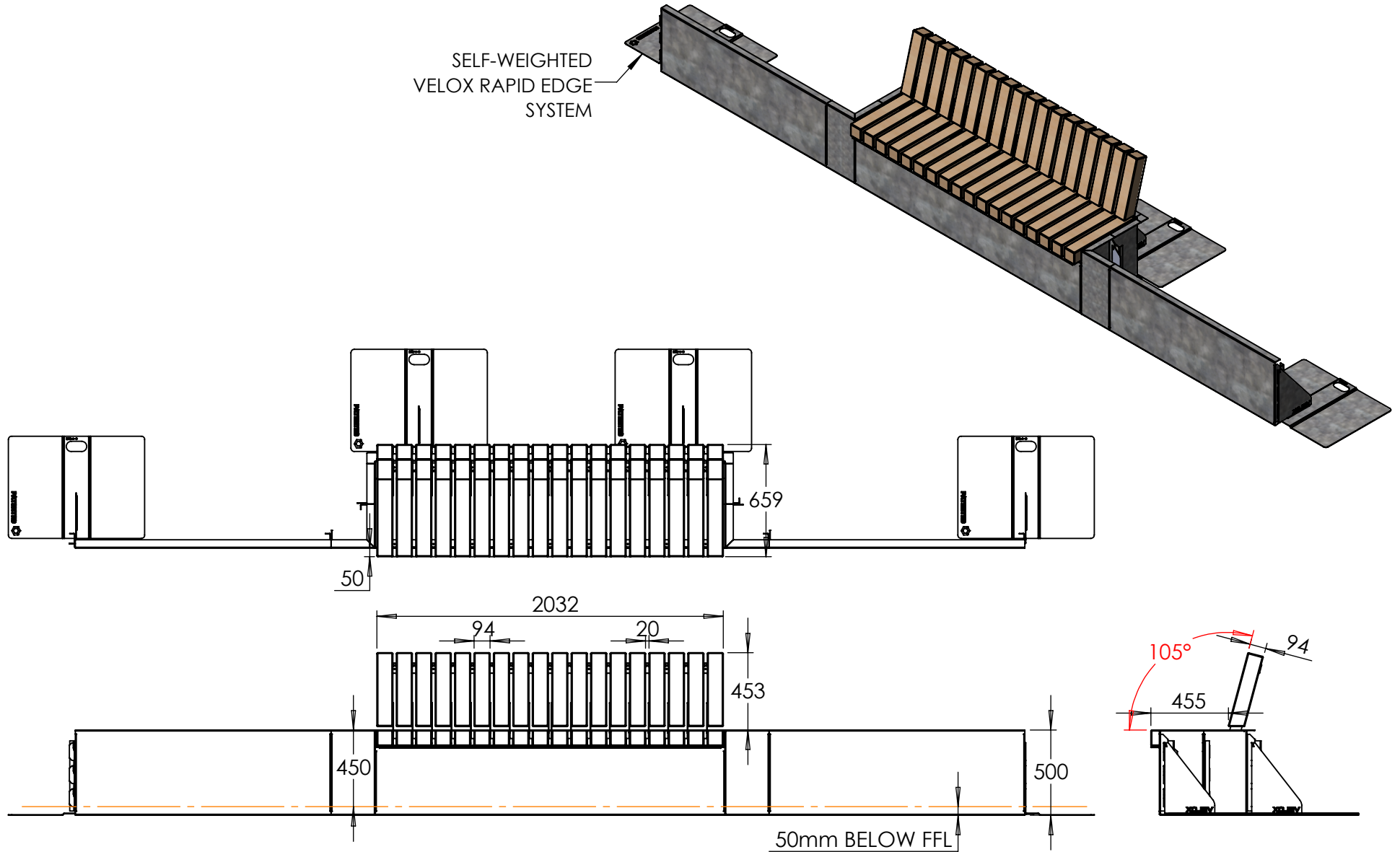

VELOX Rapid Edge™ UK00003507705 / Patent no: GB2600394 / Registered Design - Europe: 008214910 & UK: 90082149100001				Above FFL	mm	Below FFL	mm	Quantity	--
Agreed Sub-base Material:					Lateral Support:				
REVISIONS			Drawn By	SA	Linear metre	mm	STAGE	2	
REV.	AMENDMENTS/NOTE	DATE	PM	CJ					
P01	INITIAL ISSUE		Timber	94mm x 94mm (Option Dependent)					
			Metal	3mm Steel (Option Dependent)					
			Finish	Option Dependent					
TOLERANCE: All dimensions tolerance +/- 5mm			REV. P01				Product Plateau Integrated Seat No Arms Project: Website Download		
Logic Manufacture Bespoke™ 01642 373400 specification@logic-bespoke.com							DWG. NO.	Sheet No.	SIZE
Plateau Seat - Velox - No Arms							2 of 6		A4

Timber Disclaimer: All timbers lose a degree of tanning, some more than others. Timber in an external environment is susceptible to cracking, shelling and moving due to the natural drying process, this does not take away from the durability of the product. In time timber may develop surface discolouration, this is caused by natural mould feeding on the tannins and should disperse as the timber dries and turns silver. Logic are not liable for this natural process and can not be held responsible for any of these natural processes. All products to be installed in conjunction with the supplied installation guide, following the steps & guidance. All Logic products will bear some form of company branding.

SELF-WEIGHTED
VELOX RAPID EDGE
SYSTEM

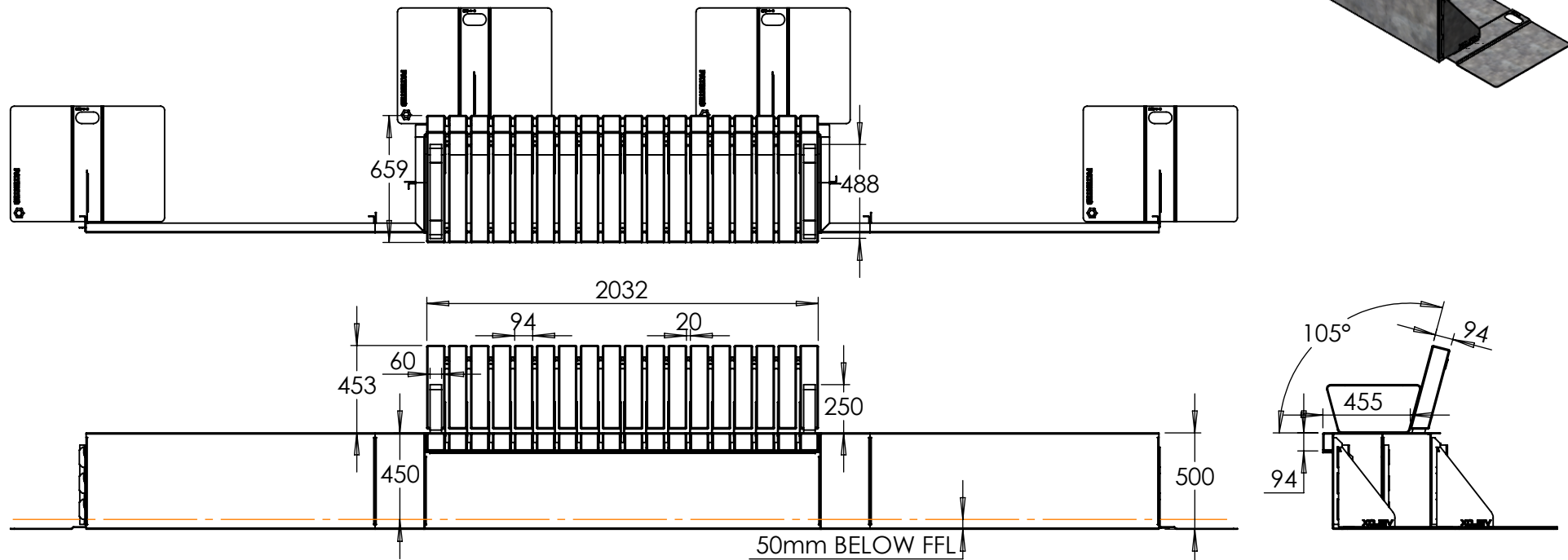
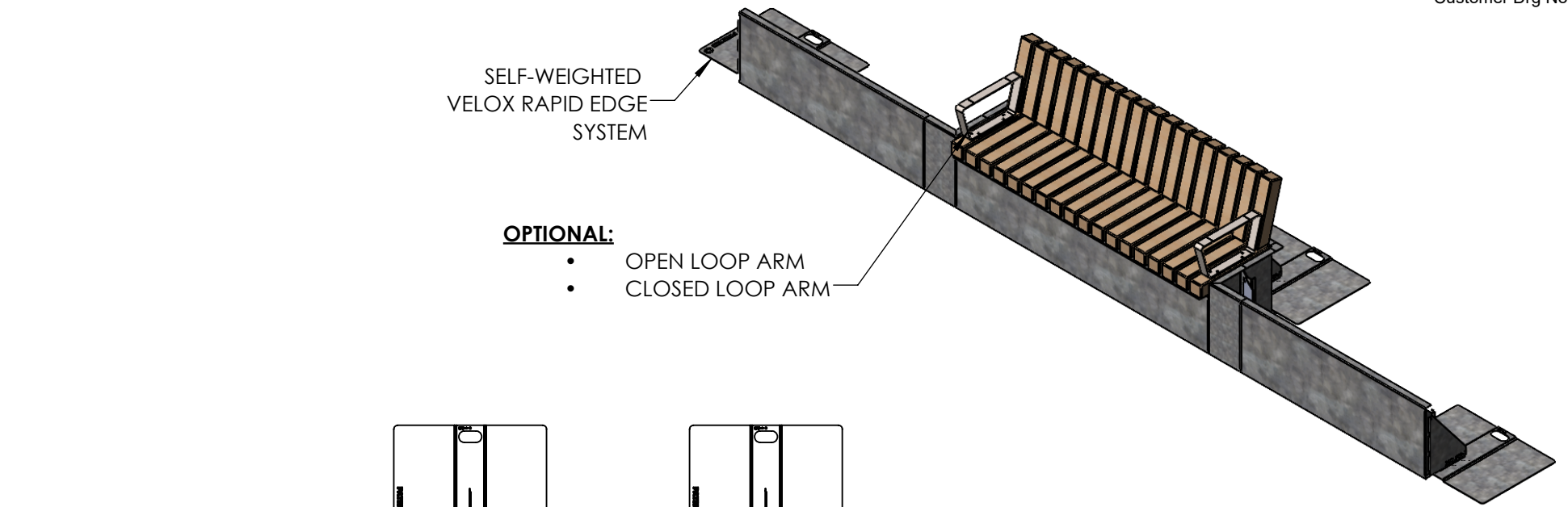

OPTIONAL:

- OPEN LOOP ARM
- CLOSED LOOP ARM



VELOX Rapid Edge™ UK00003507705 / Patent no: GB2600394 / Registered Design - Europe: 008214910 & UK: 90082149100001 | Above FFL | mm | Below FFL | mm | Quantity | --

Agreed Sub-base Material: | Lateral Support:

REVISIONS			Drawn By	SA	Linear metre	mm	STAGE	2	Product Plateau Integrated Seat Including Arms	Project: Website Download	 Logic Manufacture Bespoke™ 01642 373400 specification@logic-bespoke.com	Sheet No.	SIZE
REV.	AMENDMENTS/NOTE	DATE	PM	CJ									
P01	INITIAL ISSUE		Timber		94mm x 94mm (Option Dependent)						DWG. NO. Plateau Seat - Velox - No Arms	6	A4
			Metal		3mm Steel (Option Dependent)								
			Finish		Option Dependent								
TOLERANCE: All dimensions tolerance +/- 5mm			REV. P01	 LOGIC MANUFACTURED BESPOKE™ ALL RIGHTS RESERVED									

Timber Disclaimer: All timbers lose a degree of tanning, some more than others. Timber in an external environment is susceptible to cracking, shelling and moving due to the natural drying process, this does not take away from the durability of the product. In time timber may develop surface discolouration, this is caused by natural mould feeding on the tannins and should disperse as the timber dries and turns silver. Logic are not liable for this natural process and can not be held responsible for any of these natural processes. All products to be installed in conjunction with the supplied installation guide, following the steps & guidance. All Logic products will bear some form of company branding.

SELF-WEIGHTED
VELOX RAPID EDGE
SYSTEM

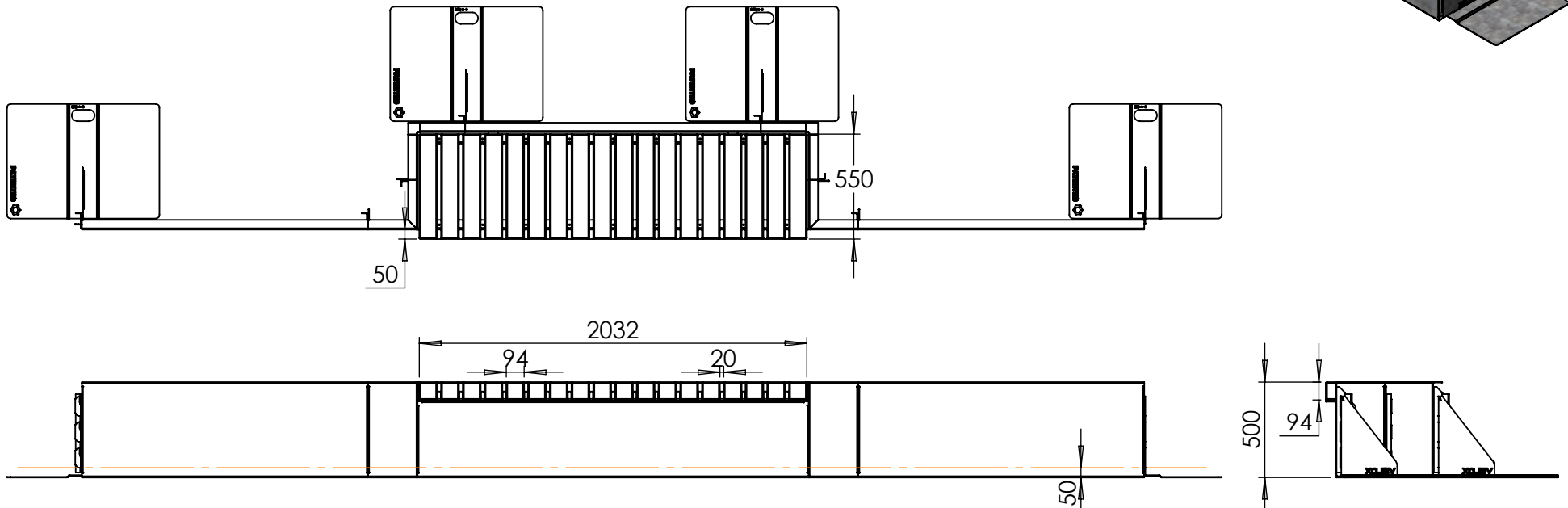
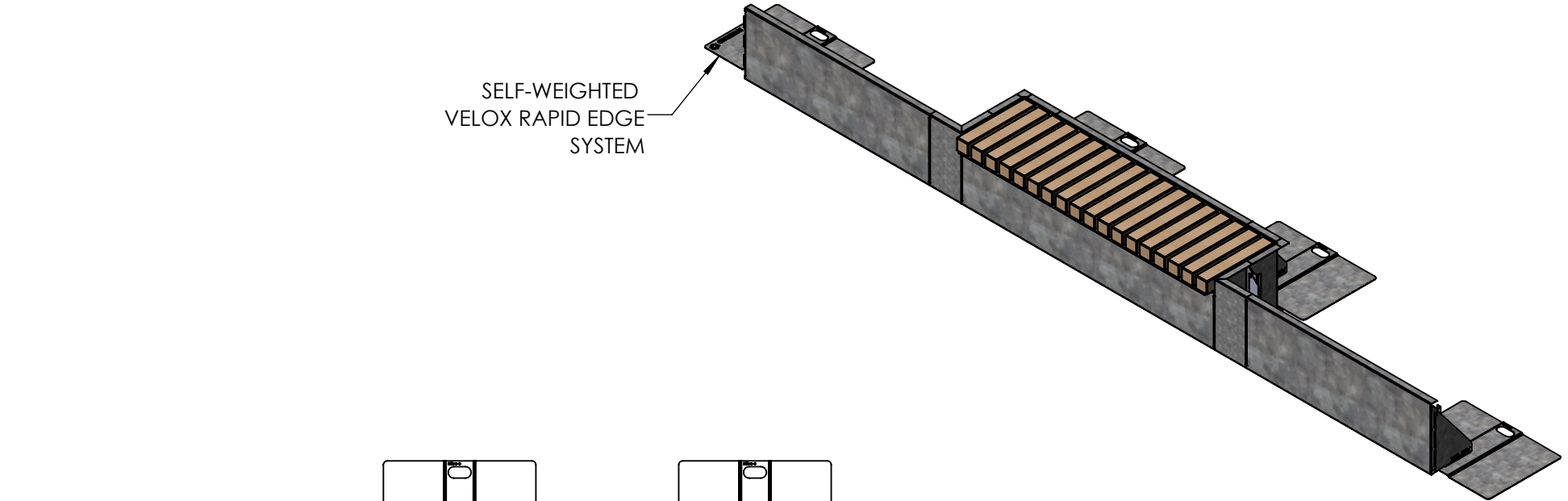

VELOX Rapid Edge™ UK00003507705 / Patent no: GB2600394 / Registered Design - Europe: 008214910 & UK: 90082149100001 | Above FFL | mm | Below FFL | mm | Quantity | --

Agreed Sub-base Material: | Lateral Support:

REVISIONS			Drawn By	SA	Linear metre	mm	STAGE	2	Product Plateau Integrated Bench No Arms	Project: Website Download	 Logic Manufacture Bespoke™ 01642 373400 specification@logic-bespoke.com	DWG. NO. Sheet No. SIZE Plateau Seat - Velox - No Arms 6 of 6 A4
REV.	AMENDMENTS/NOTE	DATE	PM	CJ								
P01	INITIAL ISSUE		Timber		94mm x 94mm (Option Dependent)							
			Metal		3mm Steel (Option Dependent)							
			Finish		Option Dependent							
TOLERANCE: All dimensions tolerance +/- 5mm			REV. P01	 LOGIC MANUFACTURED BESPOKE™ ALL RIGHTS RESERVED								

Timber Disclaimer: All timbers lose a degree of tanning, some more than others. Timber in an external environment is susceptible to cracking, shelling and moving due to the natural drying process, this does not take away from the durability of the product. In time timber may develop surface discolouration, this is caused by natural mould feeding on the tannins and should disperse as the timber dries and turns silver. Logic are not liable for this natural process and can not be held responsible for any of these natural processes. All products to be installed in conjunction with the supplied installation guide, following the steps & guidance. All Logic products will bear some form of company branding.

SELF-WEIGHTED
VELOX RAPID EDGE
SYSTEM

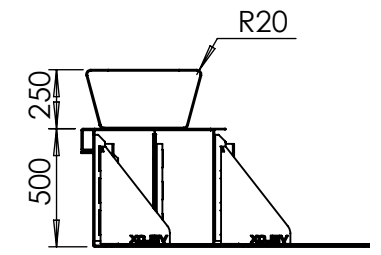
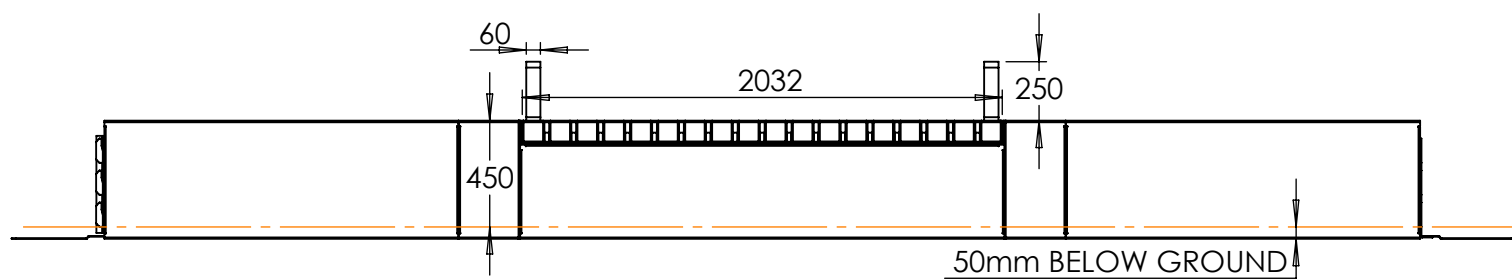
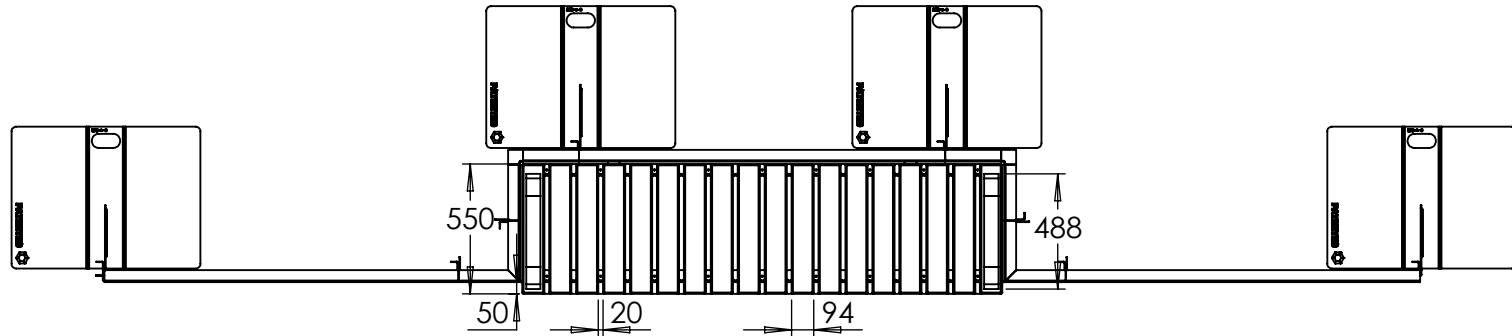
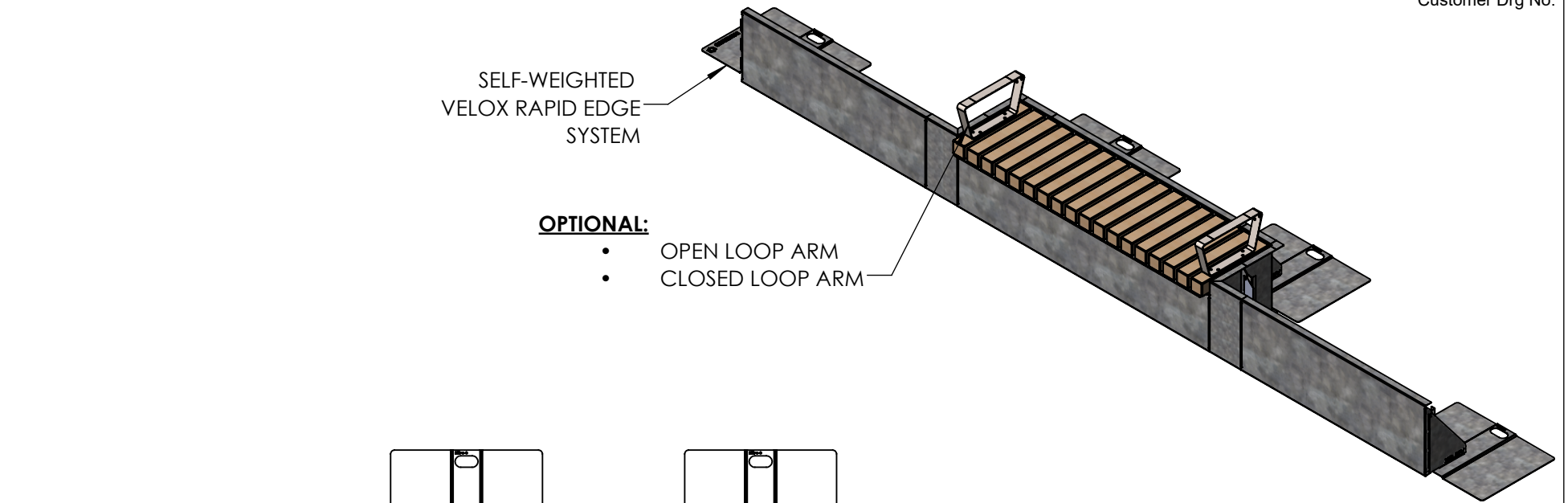

OPTIONAL:

- OPEN LOOP ARM
- CLOSED LOOP ARM



VELOX Rapid Edge™ UK00003507705 / Patent no: GB2600394 / Registered Design - Europe: 008214910 & UK: 90082149100001				Above FFL	mm	Below FFL	mm	Quantity	--
--	--	--	--	-----------	----	-----------	----	----------	----

Agreed Sub-base Material: _____ Lateral Support: _____

REVISIONS			Drawn By	SA	Linear metre	mm	STAGE	2	Product Plateau Integrated Bench No Arms	Project: Website Download	 Logic Manufacture Bespoke™ 01642 373400 specification@logic-bespoke.com	Sheet No.	SIZE
REV.	AMENDMENTS/NOTE	DATE	PM	CJ									
P01	INITIAL ISSUE		Timber		94mm x 94mm (Option Dependent)						DWG. NO. Plateau Seat - Velox - No Arms	6	A4
			Metal		3mm Steel (Option Dependent)								
			Finish		Option Dependent								
TOLERANCE: All dimensions tolerance +/- 5mm			REV. P01	  LOGIC MANUFACTURED BESPOKE™ ALL RIGHTS RESERVED									

Timber Disclaimer: All timbers lose a degree of tanning, some more than others. Timber in an external environment is susceptible to cracking, shelling and moving due to the natural drying process, this does not take away from the durability of the product. In time timber may develop surface discolouration, this is caused by natural mould feeding on the tannins and should disperse as the timber dries and turns silver. Logic are not liable for this natural process and can not be held responsible for any of these natural processes. All products to be installed in conjunction with the supplied installation guide, following the steps & guidance. All Logic products will bear some form of company branding.