

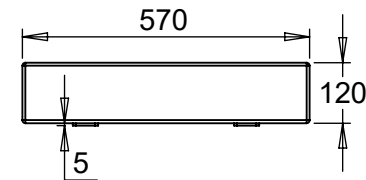

Timber:
120mm x 80mm
Pencil Round

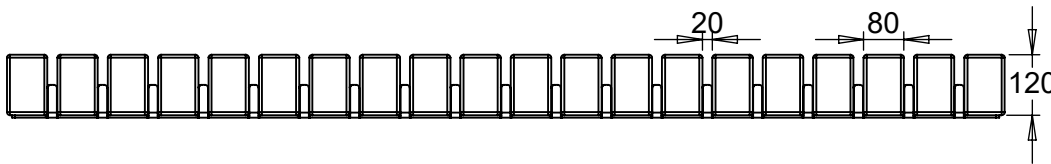
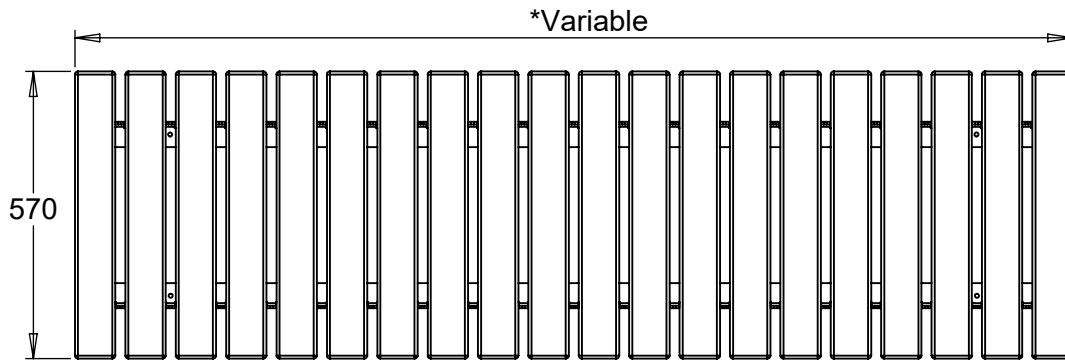
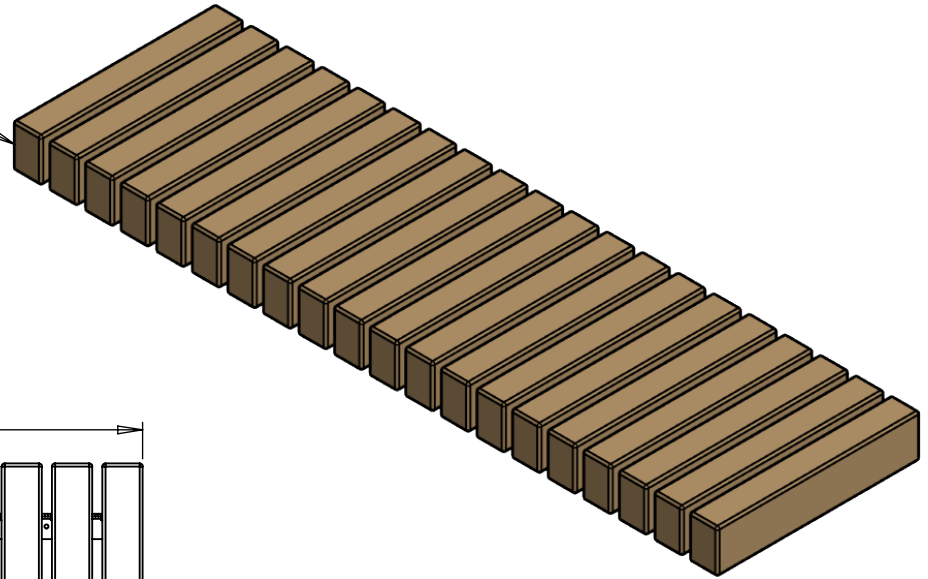

Quantity: --

*Variable Lengths: 580mm, 1380mm, 1980mm, 2380mm

Agreed Sub-base Material: --				Lateral Support: --					
REVISIONS			Drawn	SA	PM	Product			
REV	AMENDMENTS/ NOTE	DATE	Date	20/06/2023		Plateau Wall Bench			
-	-	--/--/--	Timber	Option Dependent					
-	-	--/--/--	Metal	Option Dependent					
-	-	--/--/--	Finish	Option Dependent	Weight -- KG				
-	-	--/--/--	 LOGIC MANUFACTURED BESPOKE™ ALL RIGHTS RESERVED						
TOLERANCE: All dimensions tolerance +/- 5mm								Project: -- DWG. NO. S184-PWB-0001	REV -- SIZE A4

Timber Disclaimer: All timbers lose a degree of tanning, some more than others. Timber in an external environment is susceptible to cracking, shelling and moving due to the natural drying process, this does not take away from the durability of the product. In time timber may develop surface discolouration, this is caused by natural mould feeding on the tannins and should disperse as the timber dries and turns silver. Logic are not liable for this natural process and can not be held responsible for any of these natural processes. All products to be installed in conjunction with the supplied installation guide, following the steps & guidance. All Logic products will bear some form of company branding. VELOX Rapid Edge™ - Patent Pending - GB2016654.2 - Registered Design - 9008214910001

Timber:
120mm x 80mm
Pencil Round

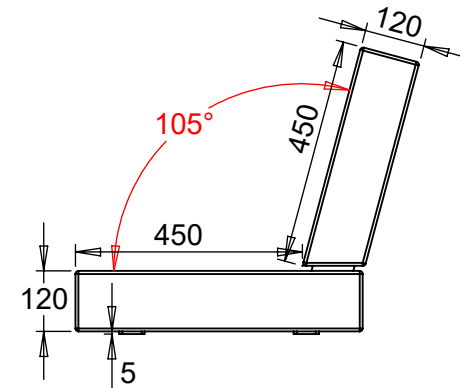
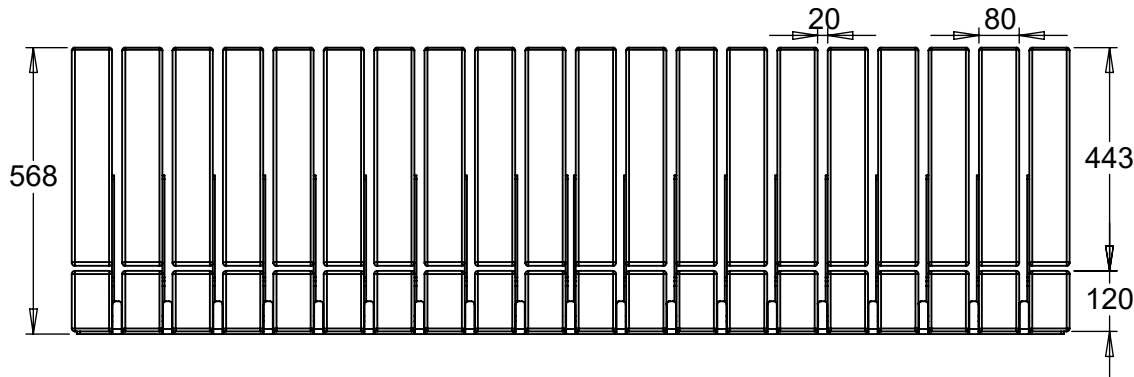
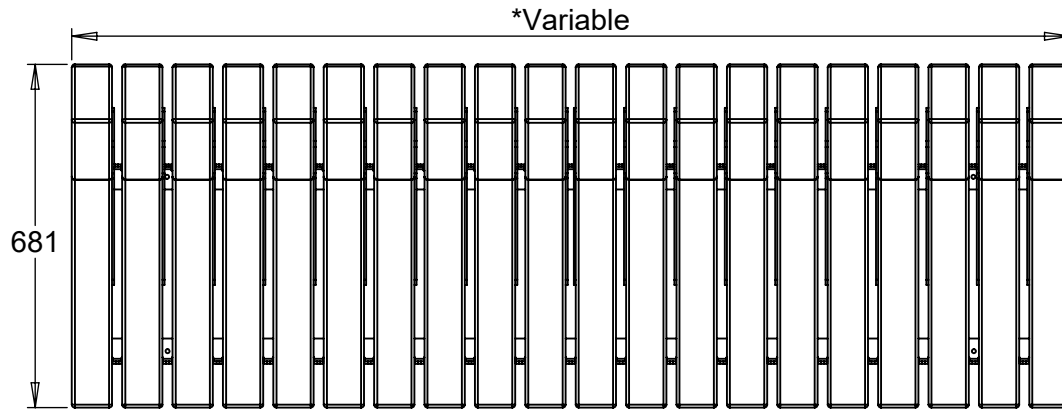
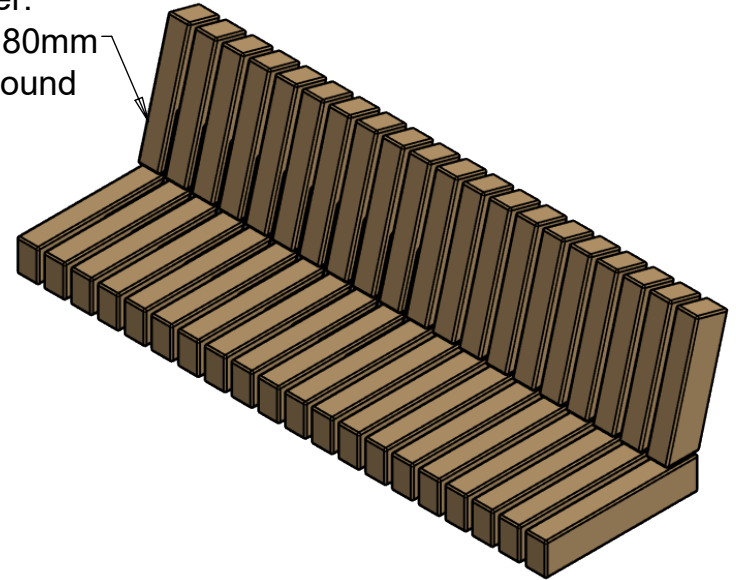

Quantity: -- *Variable Lengths: 580mm, 1380mm, 1980mm, 2380mm

Agreed Sub-base Material: -- Lateral Support: --

REVISIONS			Drawn	SA	PM
REV	AMENDMENTS/ NOTE	DATE	Date	20/06/2023	
-	-	--/--/--	Timber	Option Dependent	
-	-	--/--/--	Metal	Option Dependent	
-	-	--/--/--	Finish	Option Dependent	Weight -- KG
-	-	--/--/--	DO NOT SCALE DRAWINGS LOGIC MANUFACTURED BESPOKE™ ALL RIGHTS RESERVED		

Product
Plateau Wall Seat

Project:
--

LOGIC™
MANUFACTURED BESPOKE

Logic Manufacture Bespoke™
Project: 01642 373400 specification@logic-bespoke.com

DWG. NO.
S184-PWS-0001

REV
-- **SIZE**
A4

Timber Disclaimer: All timbers lose a degree of tanning, some more than others. Timber in an external environment is susceptible to cracking, shelling and moving due to the natural drying process, this does not take away from the durability of the product. In time timber may develop surface discolouration, this is caused by natural mould feeding on the tannins and should disperse as the timber dries and turns silver. Logic are not liable for this natural process and can not be held responsible for any of these natural processes. All products to be installed in conjunction with the supplied installation guide, following the steps & guidance. All Logic products will bear some form of company branding. VELOX Rapid Edge™ - Patent Pending - GB2016654.2 - Registered Design - 9008214910001

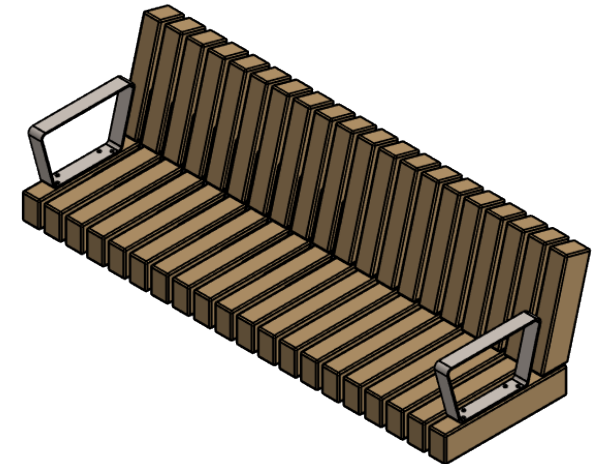
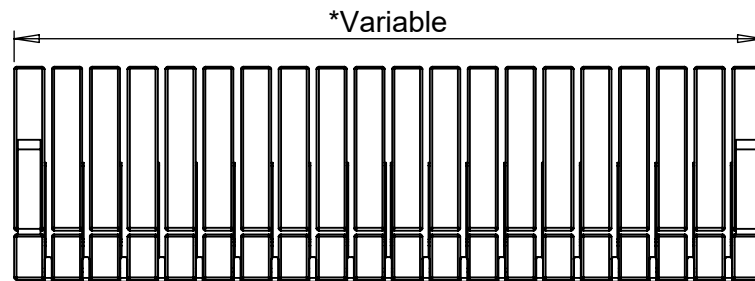
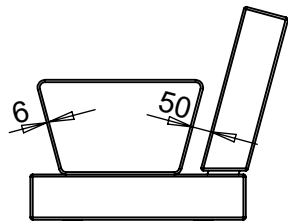
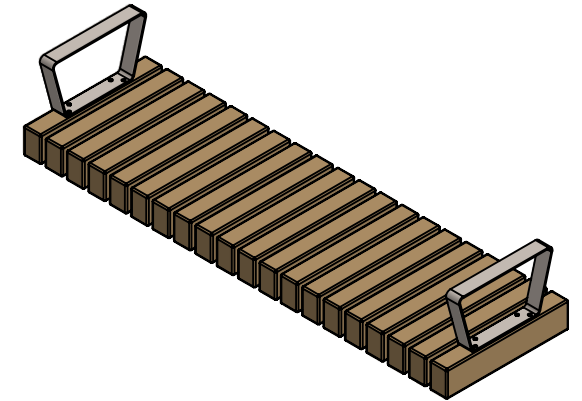
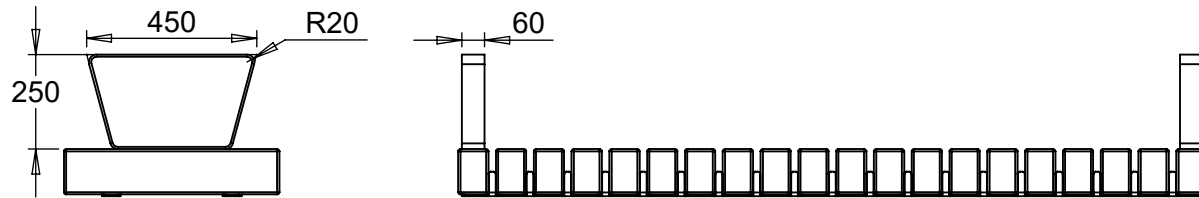

Quantity:	--	*Variable Lengths: 580mm, 1380mm, 1980mm, 2380mm		
Agreed Sub-base Material: --		Lateral Support: --		
REVISIONS		Drawn	SA	PM --
REV	AMENDMENTS/ NOTE	DATE	Date	20/06/2023
-	-	--/--/--	Timber	Option Dependent
-	-	--/--/--	Metal	Option Dependent
-	-	--/--/--	Finish	Option Dependent
-	-	--/--/--	Weight	-- KG
TOLERANCE: All dimensions tolerance +/- 5mm		DO NOT SCALE DRAWINGS	LOGIC MANUFACTURED BESPOKE™ ALL RIGHTS RESERVED	
		Product Plateau Arm Detail		 Logic Manufacture Bespoke™ Project: 01642 373400 specification@logic-bespoke.com
		Project: --		
				REV --
				SIZE A4

Timber Disclaimer: All timbers lose a degree of tanning, some more than others. Timber in an external environment is susceptible to cracking, shelling and moving due to the natural drying process, this does not take away from the durability of the product. In time timber may develop surface discolouration, this is caused by natural mould feeding on the tannins and should disperse as the timber dries and turns silver. Logic are not liable for this natural process and can not be held responsible for any of these natural processes. All products to be installed in conjunction with the supplied installation guide, following the steps & guidance. All Logic products will bear some form of company branding. VELOX Rapid Edge™ - Patent Pending - GB2016654.2 - Registered Design - 9008214910001